



Multigrain

Rice & Grain Engineering

www.multigrain.net



*Since 1920...
1920'den bugüne...*



MULTIGRAIN HAKKINDA

MULTIGRAIN BACKGROUND



MULTIGRAIN GROUP HAS A RICH AGRICULTURAL BACKGROUND

Our grandfather Mumin Kamil had entered the sector by purchasing wheat, sunflower, paddy during 1920's and later on he continued with the trading of these products. He started to load grains to İstanbul with small ships with a capacity of 300mt from the ports he formed at the villages of Sultanice and İbrice. This was the first in Thrace. Later İsmail Yetiş started rice trading and he joined İstanbul Commodity Exchange Center at 26/9/1956 as its 788'th member. He had been known as the Rice King for so long in Turkey's rice market.



İsmail Yetiş institutionalized his business with his sons and established Yetiş Gıda A.Ş in 1982. Yetiş Gıda has kept its leadership position for a long time in the rice market.

İsmail Yetiş 1982 yılında çocukları ile kurumsallaşarak Yetiş Gıda A.Ş yi kurmuştur. Yetiş Gıda uzun yıllar Türkiye pirinç piyasalarında lider olarak konumunu korumuştur.

MULTIGRAIN GRUBU ZENGİN BİR TARIMSAL ÖZGEÇMİŞE SAHIPTİR

Dedemiz Mümin Kamil 1920'lerde buğday, ayçiçeği ve çeltik tarımıyla Trakya da sektöre girmiş, daha sonralarda bu ürünlerin ticaretini de yaparak devam etmiştir. İbrice ve Sultanice de iki liman oluşturarak 1930 lu yıllarda İstanbulla 300 mt luk takalarla ürün yüklemeye başlamıştır. Bu Trakya da bir ilktir. Daha sonra İsmail Yetiş Pirinç ticaretine başlamış 26/9/1956 yılında 788 inci üye olarak İstanbul Ticaret Borsasına kayıt yaptırmış ve çok uzun yıllar Türkiye piyasalarında Pirinç Kralı olarak isim yapmıştır.





CEO REVIEW



TURGAY YETİŞ

Multigrain A.Ş. President & CEO

A MESSAGE FROM THE CEO

Being a third-generation experienced rice and grain family business, we continue to acquire new knowledge in our field every day. In line with our past experience, the most important thing is customer satisfaction. Due to this we prioritize our business to have the qualities of honesty, superior quality controls and services as well as timely deliveries. Keeping our promises is a part of our corporate culture and very first priority.

We continuously work to benefit from new technologies, bring innovative solutions and profits to our customers. We will continue to thrive in bringing new technologies to our industry. We have been building high-performance factories across different countries, creating a family spirit among our colleagues, and adding our customers to our ever-growing family institution.

As Multigrain team, we will continue to work harder, and to uphold the highest standards for customer satisfaction. Please continue to follow us for further technological advancements..

CEO'NUN MESAJI

Biz üç Jenerasyondan gelen, pirinç ve tahıl tecrübesi olan bir firma olmamıza rağmen hala her gün bir şey öğreniyoruz. Tecrübelerimize göre en önemli konu müşteri memnuniyetidir. Bunun için doğruluk, kalite, servis, zamanında teslimat, bir firmanın başarısı için öncelikli konulardır.

Verdiğimiz sözü tutmak şirket geleneklerimizin başında gelir. Yeni teknolojileri takip ederek müşterilerimize kar ettirmek, innovative çözümler sunmak için durmadan çalışıyoruz. Sektörümüze bugüne kadar getirdiğimiz yeniliklere devam edeceğiz. Faaliyet gösterdiğimiz birçok ülkede başarılı tesisler kurarak, tüm personelimizle birlikte aile felsefesini benimseyerek yol katediyoruz ve müşterimiz olan her yeni işletmeyi de aileye dahil ediyoruz.

Multigrain ekibi olarak, başarılarımızın devamı için var gücümüzle çalışacağız. Müşteri memnuniyetimizden de ödün vermeyeceğiz.

Yeni teknolojilerimiz için bizi takip etmeye devam edin..



QATAR KATAR

Rice is the world's most consumed food source. Our company has been building a 1200 MT tons per day capacity rice processing, packaging and feed plant under the scope of "Port Hamad Food and Safety Project" led by Qatar Doha's Transport and Telecommunication Ministry . This project has been of great importance within the world and the Gulf region. Multigrain Family's 3 generations of experience have played an important role in the implementation of this project.

Pirinç Dünyanın en çok tüketilen besin kaynağıdır. Katar Doha'da Ulaştırma ve Telekomünikasyon Bakanlığı'nın "Hamad Limanı Gıda Güvenliği Projesi" kapsamında, günde 1200 ton kapasiteli pirinç işleme, paketleme, yem tesisi yapıyoruz. Yapmakta olduğumuz bu proje Dünya genelinde ve Körfez bölgesinde pirinç konusunda ,en önemli projeler arasında yer almaktadır. Multigrain ailesinin 3 kuşaklık tecrübesi bu projenin alınmasında etken rol oynamıştır.



GREECE YUNANİSTAN

Greece is the largest paddy producer of the Balkans and in the city of Orestiada, Multigrain has built a new modern Rice milling facility with a daily production capacity of 350 MT. The rice mill has been standing out with excellent processing and high-degree of efficiency.

Balkanların en büyük pirinç üreticisi Yunanistan'ın Orestiada şehrinde günde 350 MT gün kapasitesine sahip tesisi tek işleme hattında en son üretilen makinalar la işletmeye aldık. Değirmen Mükemmel işleme kalitesi ve yüksek randıman verimi ile kendini göstermektedir.





RICE FACILITIES

LIBYA LIBYA

Libya is the gateway to North African food source. Multigrain has built the most modern facilities of 700 mt/PD rice milling, packing and by product feed milling facilities, as a company, serving to all Eastern Libyan territory.

Orta Afrika'nın gıda kapısı olan Libya'nın Tobruk şehrinde bölgeye hizmet verecek yatırımın bir parçası olarak günde 700 MT/Gün Çeltik işleme, Pirinç paketleme ve yem tesisi yaptık, işletmede tüm çıkan yan ürünler yem olarak değerlendirilecektir.



TURKEY TÜRKİYE

In Turkey, Thrace region, a rice milling and drying factory has been built with a daily capacity of 500 MT, and it will undertake production with the highest quality standards and hygiene.

Türkiye'de Trakya da kurulan günlük 500 MT gün kapasiteli çeltik işleme ve kurutma tesisi tüm ülkeye yüksek kalite standardı, hijyen yapısı ve kaliteli üretimi ile hizmet veriyor.



UKRAINE UKRAYNA

In addition to the facilities Multigrain has constructed in Ukraine, we have built a brand new rice milling factory in Odessa which will serve the entire nation. This facility has the daily capacity to produce 250 MT grains daily equipped with cutting edge new technology.

Ukrayna da faaliyet gösteren yaptığımız tesislere ilave olarak, Odessa şehrinde ülkeye hizmet verecek yeni bir pirinç işleme tesisi işletmeye alınmıştır. Günde 250 MT çeltik işleme kapasitesine sahip tesis son teknoloji makinalar ile donatılmıştır.





Corn is an important food source, it is a primary food category that has many uses from food consumption to animal feed. At the same time the oil embedded in its embryo is consumed as a food oil alternative.

As Multigrain we first eliminate and clean the corn, later by degermination technique splitting the corn from its shall to produce the raw material. In the meantime we undertake alternative methods to produce the side materials for corn. In conjunction to this process, we produce cornflour, corn oil, other consumption food (chips etc) and feed raw material for other usages. Our company has expertise in these various processes.

Mısır çok önemli bir gıda kaynağıdır. Bir çok alanlarda kullanımı vardır, hem gıda tüketiminde çok çeşitli formatlarda kullanılmaktadır. Hemde yem sektöründe çok değişik formatlarda kullanılmaktadır. Aynı zamanda embriyosunda içerdiği yağ ile insanlar için yemeklik yağ olarak da kullanılmaktadır .

Biz önce mısırı eleyip, temizleyip daha sonra degerminatör vasıtası ile kabuğundan ayırıp hammadde haline getiriyoruz. Bu arada yan ürünlerde değerlendirecek şekilde ayrı işlemlere tabi tutuluyor. Buna bağlı olarak mısır unu , mısır yağı , gıda tüketim ürünleri (cips gibi) ve yem ham maddesi ve daha birçok sektörde kullanılmaktadır. Şirketimiz tüm bu konularda çalışmaları mevcuttur.

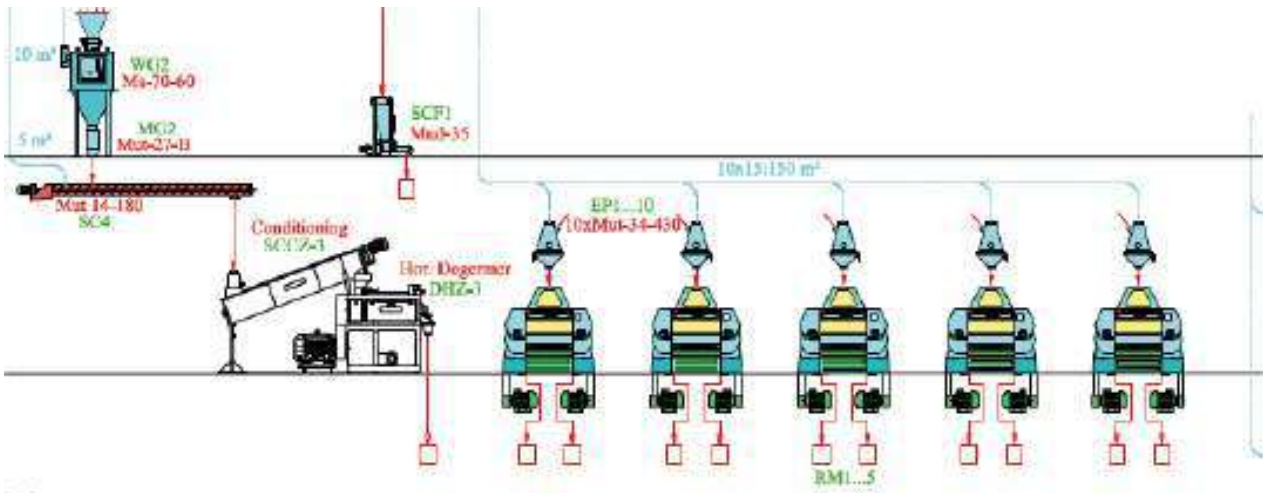



PACKAGING FACILITIES

Our packaging facilities aide in the packaging of rice, sugar, grain, detergents and other various products. As well as packing, we can do bailing of the groups and boxing them. Multigrain has the capacity to use robots that can arrange on pallets with the use of modular systems.

Pirinç, şeker, bakliyat, deterjan gibi çeşitli ürünleri değişik ambalaj ebatlarında paketlenip, bu paketleri de isteğe göre balyalayabilen ya da kolileyeabilen; bu kolilenen ürünleri de paleta dizebilen ROBOT ve modüler sistemlerimiz mevcuttur.

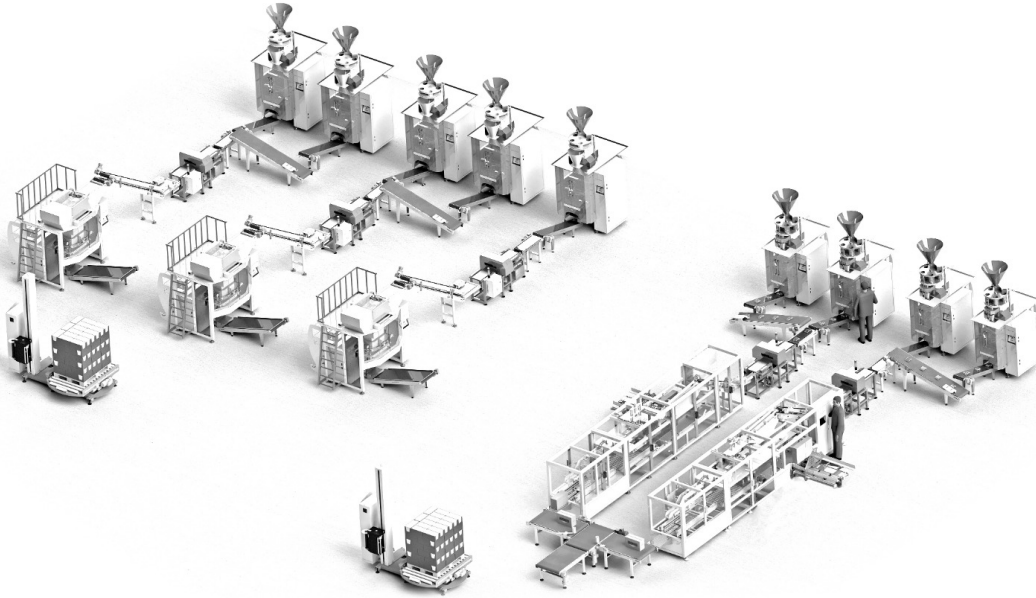



Indent Cylinder Separator



Classtoner



Fan



Micro Cleaning

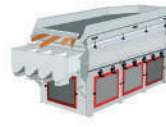

Gravity Separator



Hopper



Super Magnet



Packing Machine

The importance of food supplies have gained greater importance in our day of age. Producing the high calibre food requires high quality seeds. Multigrain possesses high quality technology seed equipments to increase the value of your seed. Seed is a crucial element for grain production and with the use of our special machinery we acquire high quality seed.

Günümüzde gıdanın önemi artmıştır. Kaliteli gıda için kaliteli tohum gerekmektedir. Multigrain yüksek teknolojiye sahip tohum ekipmanları ve tesisleri ile ürününüze değer katar. Tohum bir çok tahıl için önemlidir. Özel makinalarımız sayesinde yüksek kalite tohum elde etmek mümkündür.

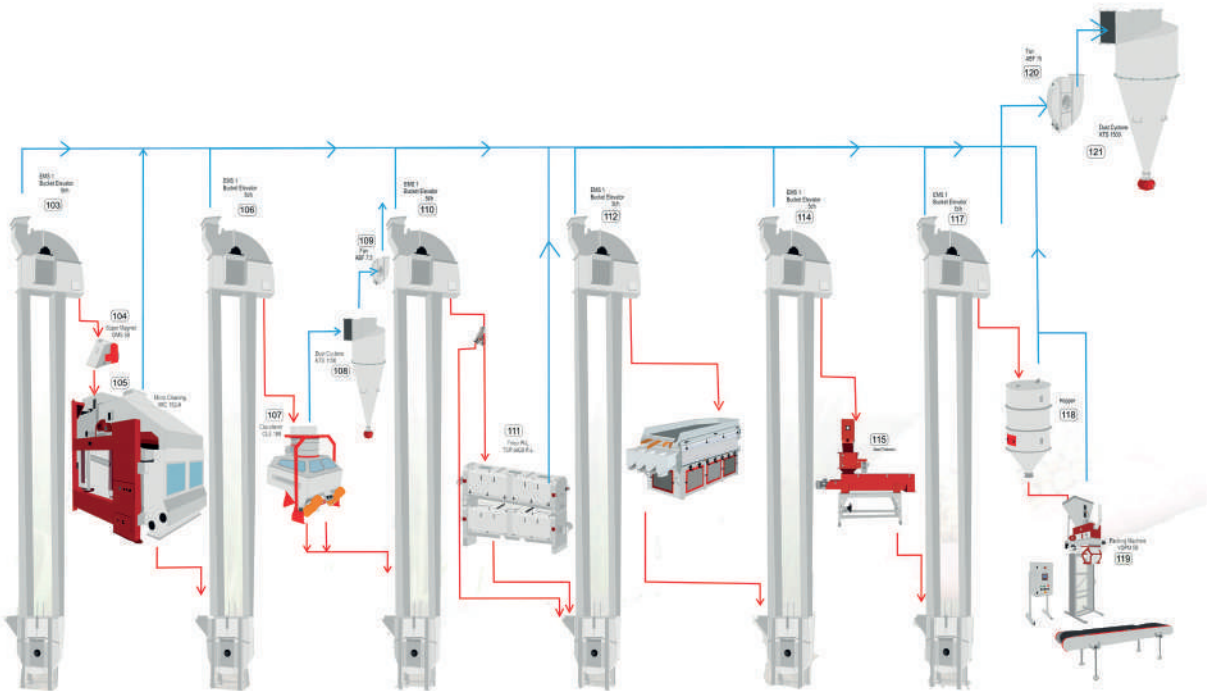



GRAIN DRYER

PEDROTTI DRYING SYSTEMS

Multigrain has a license agreement with the Italian Pedrotti Company, one of Europe's most known and sold brands and an industry leader in Mobile Grain drying systems. We produce Pedrotti machinery at our facilities in Turkey and make their sale.

PEDROTTİ KURUTMA SİSTEMLERİ

Avrupa'nın en çok bilinen ve satılan markası olan ve kurutma sistemlerinde sektörün lideri konumunda olan Pedrotti şirketi ile lisans anlaşmamız mevcut olup Multigrain ailesi olarak makinaların Türkiye'de üretimini, toplanmasını, satışını ve ihracatını yapmaktayız.



SUNCUE FIXED DRYING SYSTEMS

Suncue fixed drying systems are high technology, easy-to-use, drying systems with minimum fuel consumption. As fuel; gas, diesel and biomass (paddy husk, straw, corncob, nutshell, wood, coffee husk..) can be used.

SUNCUE SABİT KURUTMA SİSTEMLERİ

Suncue sabit kurutma sistemleri yüksek teknolojiye sahip kolay kullanımlı, minimum yakıt sarfiyatlarına sahip kurutmalardır. Yakıt olarak; gaz, dizel ve biomass (çeltik kabuğu, saman, mısır koçanı, fındık kabuğu, odun, kahve kabuğu..) kullanılır.



FABRIKA ZA ORIZ
DIANIYO
s. G. Peddig - Kurani



arbel



**METİN
GIDA**

sezerler

SINMAZLAR

**UYGAR
GRUP**

FACILITIES AROUND THE WORLD
GLOBAL TESİSLERİMİZ



ELEVATOR SİSTEMLERİ

Ati-tech elevator sistemleri toz ve granül halindeki maddelerin dikey yönde taşınmaları için tasarlanmıştır.

İstenilen kapasite ve yüksekliğe göre değişik modelleri mevcuttur. Çeltik & pirinç için özel olarak tasarlanmış anti-statik ürüne hasar vermeyen kovalar kullanılmaktadır.

ELEVATOR SYSTEMS

Ati-tech elevator systems are made for grains and rice. We have different capacities

They are specially designed for not breaking the product and used our anti-static plastic buckets.



BİGBAG

Ati-tech bigbag dolum makinesi 2.500 kg'a kadar taşıma kapasitesi ile her türlü akışkan kıvamdaki toz ve granül ürünlerin minimum 500 kg'dan 2.500 kg'a kadar tartılarak paketlenmesine olanak sağlar. Makine isteğe bağlı olarak, tesis içerisinde değişik alanlarda kullanılabilmesi için mobil olarak ta üretilebilir. Kullanıcı kolaylığı sağlayan dokunmatik plc ekran ile donatılmıştır. Tartım üniteleri BAYKON, pnomatik ürünler FESTO'dur. Bakım ve kullanımı oldukça basit, yedek parça gerektirmeyen modüler ve geniş kullanım alanına sahip kullanışlı bir makinedir.

BIG-BAG

Ati-tech bigbag model filling machine with a carrying Ati-tech bigbag model filling machine with a carrying powder and granular products between the range of powder and granular products between the range of to produce the equipment mobile type as to use it at different places in the facility. It is equipped with user friendly touch screen control panel. Weighing units are BAYKON, while pneumatics are FESTO. It is very useful machine that does not need any spare parts and has easy maintenance and use.

MODÜLER AMBAR SİSTEMLERİ

Ati-tech tech ambar sistemleri müşterilerin depolama ihtiyaçlarını karşılamak için, kullanım amacına ve kullanım yerine bağlı olarak üretilebilen, ileride ekleme yaparak kapasite artırımı imkanı sunan kaynaklı tasarım civatalı monte modüler sistemlerdir. Depolanmak istenen ürün çeşidine uygun olarak özel isteğe göre sac veya krom malzemedan üretilir. Ati-tech silindirik ambar sistemleri müşterilerin küçük kapasiteli depolama ihtiyaçlarını karşılamak için tasarlanmıştır. Seri bir şekilde temin edilerek istenilen noktaya monte edilebilir. İsteğe bağlı olarak alt konik yüksekliği, çuval veya big-bag dolduracak şekilde üretilebilir.

MODULAR STORAGE SYSTEMS

Ati-tech cylindrical storage bin systems designed to meet customers small amount of storage requirements. They can be supplied quickly and can easily be installed to desired place. Lower conic can be produced according to fill bag or big-bags. Ati-tech storage bin systems are designed to meet customers storage requirements. They are non welded modular systems which is possible to design according to usage area and possible to increase the capacity in the future by adding next to each other.





LABORATORY MACHINES



**PAZ 1/DTA MODEL
RANDIMAN MAKİNESİ**

**PAZ 1/DTA MODEL
LABORATORY MACHINE**

PİRİNÇ MİKROSKOPU

MICROSCOPIC



OTOMATİK TANE SAYICI

AUTOMATIC SEED COUNTER



**PAZ 2/DTA MODEL OTOMATİK
RANDIMAN MAKİNESİ**

**PAZ 2/DTA MODEL AUTOMATIC
LABORATORY MACHINE**

SIKMALI NEM ÖLÇER

MOISTURE TESTER



**MBZ-2 MODEL
BEYAZLIK ÖLÇER**

**MBZ-2 MODEL
WHITENESS METER**



ÇELTİK SOYUCU

PADDY HUSKER



**GÖRÜNTÜ
ANALİZ CİHAZI**

RICE ANALYZER

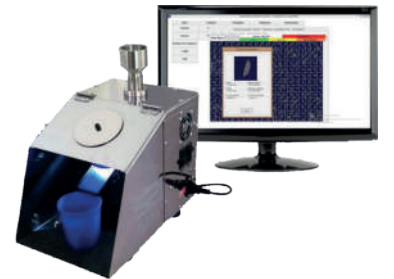

PİRİNÇ BEYAZLATICI

RICE WHITENER



TEK TANE NEM ÖLÇER

**SINGLE KERNEL
MOISTURE TESTER**



RENK AYIRMA SİSTEMLERİ

SORTING MACHINES



Multigrain is a representative of world leader color sorting machinery Anzai- Japan. These machines can sort all products with many different models even with high aflatoxin kernels. Electromagnetic stones separating machines can sort stones and soil from the grain.

Renk ayırma sistemlerinde dünyanın lider markası Anzai'nin temsilciliği yapılmaktadır. Varolan sistemler ile aflatoksinli taneler bile görüntü ile ayıklanmaktadır. Ayrıca elektromanyetik ortamda taş ve toprak gıda maddelerinizden ayıklanabilmektedir.



LC-Series
LC-Serisi



FACILITIES IN TURKEY
TÜRKİYE'DEKİ TESİSLER



LEO-Series
LEO-Serisi



BMR-Series
BMR-Serisi



REFERENCES



FACILITY
450 mt/day Rice Mills

LOCATION
BULGARIA



FACILITY
200 mt/day Rice Mills
300mt Grain Dryer

LOCATION
BULGARIA



FACILITY
150 mt/day Whitening line

LOCATION
BULGARIA



FACILITY
350 mt/day Rice Mills

LOCATION
GREECE



FACILITY
200 mt/day Rice Mills

LOCATION
GREECE



FACILITY
200 mt/day Rice Mills

LOCATION
GREECE



FACILITY
150 mt/day Rice Mills

LOCATION
GREECE



FACILITY
150 mt/day Rice Mills

LOCATION
GREECE



FACILITY
350 mt/day Rice Mills

LOCATION
LIBYA



FACILITY
350 mt/day Rice Mills

LOCATION
LIBYA



FACILITY
700 mt/day Rice Mills

LOCATION
LIBYA



FACILITY
350 mt/day Rice Mills

LOCATION
LIBYA



FACILITY
200 mt/day Rice Mills

LOCATION
LIBYA



FACILITY
50 mt/day Grain Dryer

LOCATION
N. MACEDONIA



FACILITY
50 mt/day Grain Dryer

LOCATION
N. MACEDONIA



FACILITY
100 mt/day Grain Dryer

LOCATION
N. MACEDONIA



FACILITY
1200 mt/day Rice mill
560 mt/day Packing
Feed section

LOCATION
QATAR



FACILITY
200 mt/day Rice Mills

LOCATION
RUSSIA



FACILITY
Corn Mills

LOCATION
RUSSIA



FACILITY
200mt/day Rice Mills

LOCATION
UKRAINE

FACILITIES AROUND THE WORLD
GLOBAL TESİSLERİMİZ



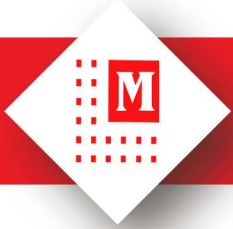

REFERENCES



FACILITY
200 mt/day Rice Mills



FACILITY
150 mt/day Rice Mills



FACILITY
250 mt/day Rice Mills



FACILITY
350 mt/day Rice Mills



FACILITY
150 mt/day Rice Mills



FACILITY
200 mt/day Rice Mills



FACILITY
200 mt/day Rice Mills



FACILITY
Quality Control Labs



FACILITY
200 mt Color sorting



FACILITY
Magnetic de-stoner



FACILITY
200 mt/day Rice Mills



FACILITY
150 mt/day Rice Mills



FACILITY
200 mt/day Rice Mills
250 mt/day Grain Dryer



FACILITY
Magic de-stoner



FACILITY
200 mt/day Rice Mills



FACILITY
150 mt/day Rice Mills



FACILITY
450 mt/day Rice Mills



FACILITY
150 mt/day Rice Mills



FACILITY
150 mt/day Rice Mills



FACILITY
200 mt/day Rice Mills



FACILITY
150 mt/day Rice Mills



FACILITY
100 mt/day Rice Mills
Silo



FACILITY
200 mt/day Rice Mills
500 mt/day Grain Dryer



FACILITY
200 mt/day Rice Mills



FACILITY
500 mt/day Rice Mills



FACILITY
200 mt/day Rice Mills



FACILITY
200 mt/day Whitening



FACILITY
Quality Control Labs



FACILITY
500 mt/day Grain Dryer



FACILITY
150 mt/day Rice Mills



FACILITY
5 mt / day
Seed Cleaning Facility



FACILITY
Alfatoxin sorting



FACILITY
200 mt/day Rice Mills



FACILITY
450 mt/day Rice Mills



FACILITY
200 mt/day Packing Facility

**FACILITIES IN TURKEY
TÜRKİYE'DEKİ TESİSLERİMİZ**



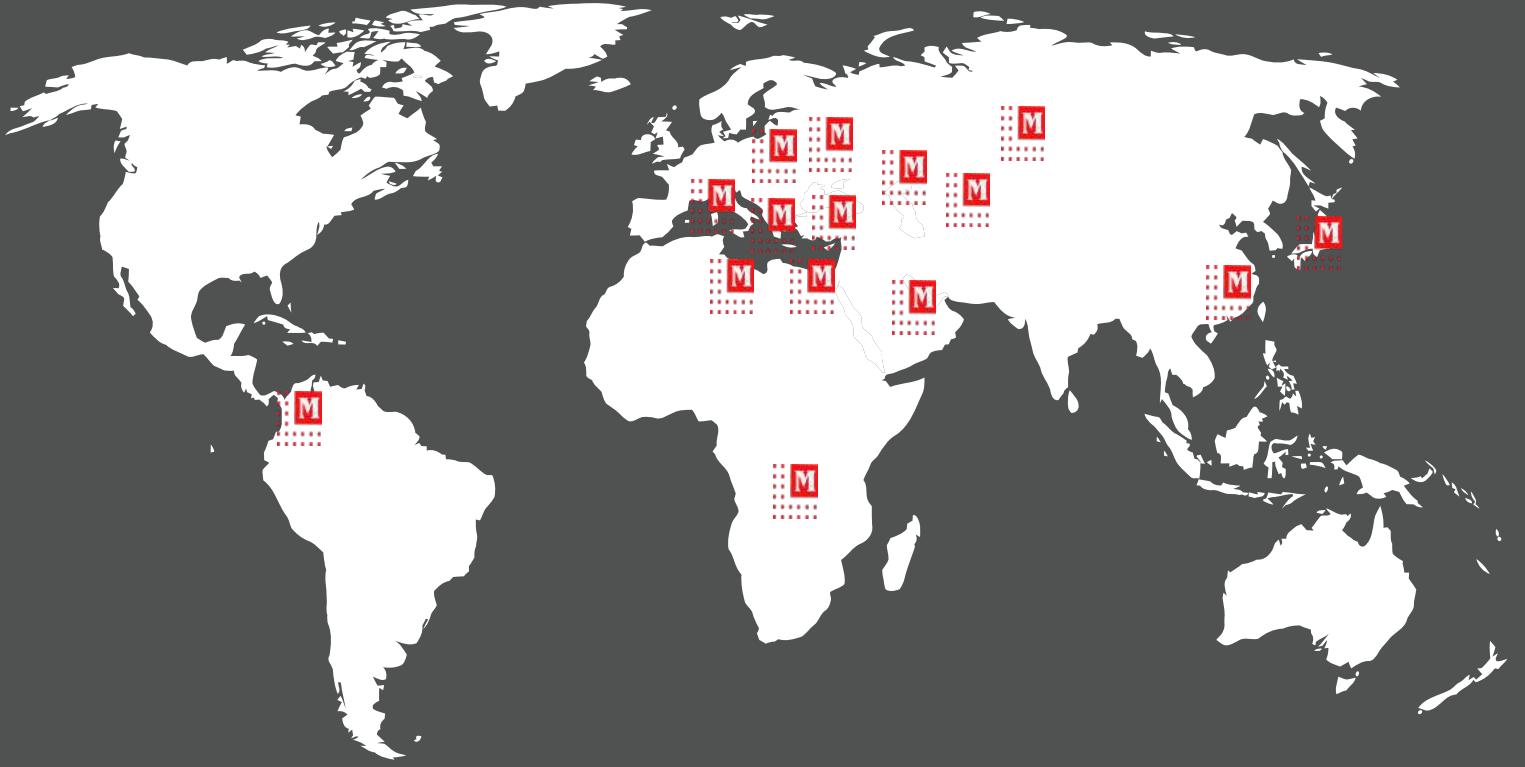

Multigrain

Rice & Grain Engineering



 Gökçedere Mevkii,
Saricaali Kavşağı No:384
İpsala / EDİRNE / TURKEY

 +90 544 714 96 41

 +90 284 714 96 41

 +90 212 381 79 30

 export@multigrain.net

 www.multigrain.net



Multigrain
Rice And
Grain
Engineering